

SHA-PAX-110

Operating and Installation Instructions

Dimensions

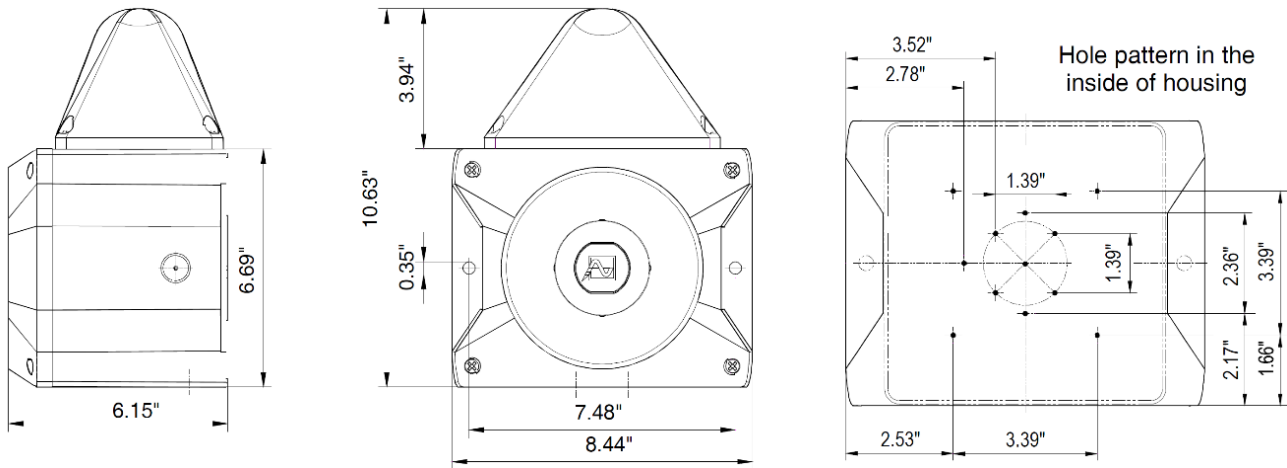

Specifications

Nominal sound level	110dB (A) 1m	
Volume control	max. -10dB	
Tones	80	
Flash energy	10 Joules	
Flash frequency	1 Hz	
Operating voltage	24 VDC (18-30 VDC)	120 VAC (95-127 VAC)
Current draw Sounder (max)	360 mA	150 mA
Current draw Beacon (max)	680 mA	300 mA
Duty cycle	100%	
Connection terminal	AWG 24 – AWG 14 (stranded)	
Ingress protection	IP66, Type 4 & 4x	
Resistance against impact	IK08 (EN50102)	
Operating temperature	-40°F to +130°F (-40°C to +55°C)	
Max RH%	90%	
Cable entry	4x M20 (prepared)	
Material of housing	PC/ABS Blend	
Material of lens	PC	
Lens colors	clear, white, yellow, amber, red, green, blue	
Certifications	UL, cUL, CE	

Installation

Safety notes:

- Installation must be carried out by an electrician in compliance with the latest codes and regulations.
- **Danger:** High voltage may be present.
- Prior to opening, it must be ensured that no voltage is applied to the device.
- Before electrical connection, the supply voltage on the type plate is to be checked. The wrong operating voltage can lead to damages or to the destruction of the equipment.
- During installation it must be ensured that the connection cables are secured against tension and distortion.
- **Caution:** During installation, route field wiring away from sharp projections, corners and internal components.
- The opening of the bell mouth must not point upwards, especially in the case of use outdoors or in a particularly dusty environment.
- The function of the unit is only guaranteed if the upper and lower section is joined correctly.
- In order to prevent detriment to sight, continuously looking directly in the activated light is to be avoided.

Opening the housing:

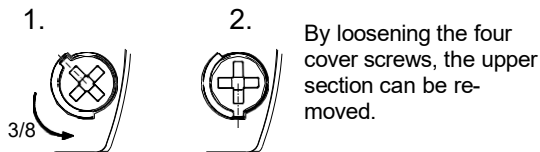

Closing the housing

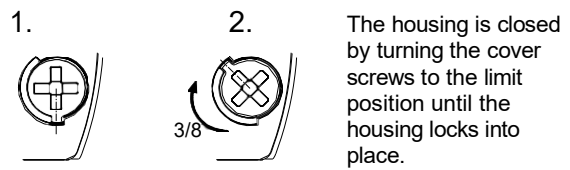

The unit is not closed when delivered.

Sealing plugs for the housing screws are available as accessories.

Cable gland entries

To guarantee the specified protection type, use proper conduit fittings.

Wiring

Circuit board for electrical connection (located in the base section):

Terminal for operating voltage - Sounder-beacon combination:

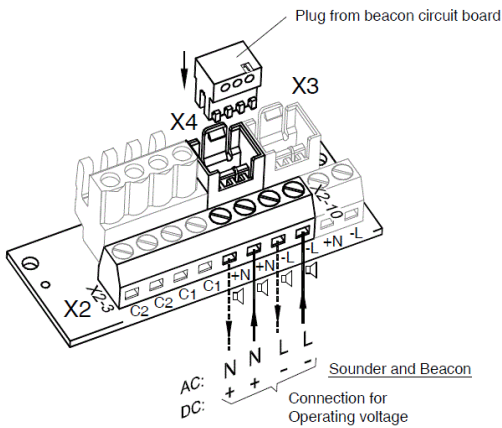

Strobe and horn to operate together

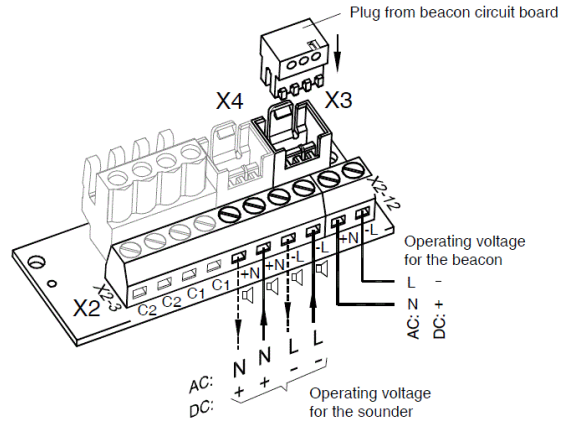

Strobe and horn to operate independently

Driver circuit board of sounder (located in the upper section):

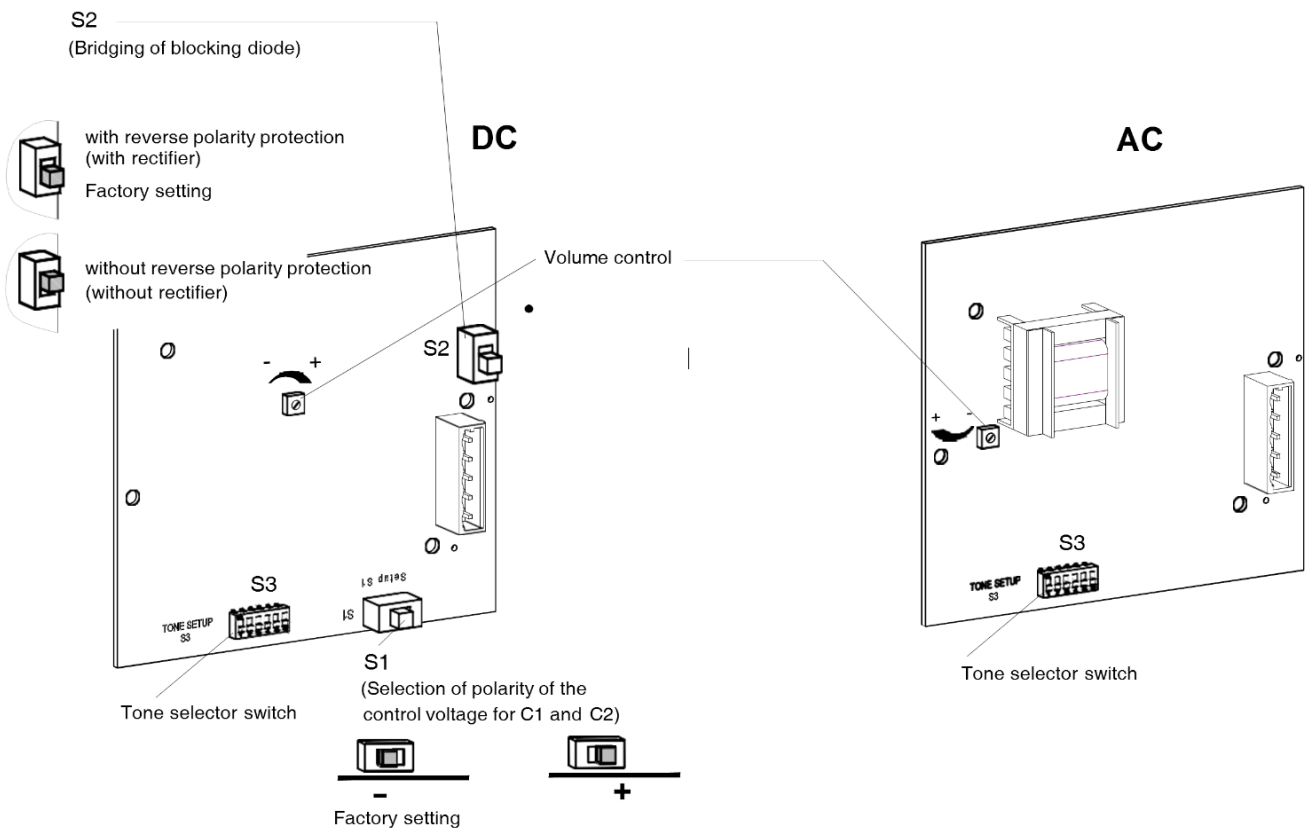

Change of the tones by external control

The following instructions are only used if multiple tones are desired using multiple voltage inputs.

For applications which require more tones than just the base tone, it is possible to provide up to three additional tone types with the use of the following electrical controls.

As a basic rule, the desired base tone is set with the tone selector switch S3 on the driver board. The corresponding additional tones (C1, C2, C1+C2) can be gathered from the table "Selection of the tones".

Tone selection with control input

DC-Version:

When used with correct polarity, the tone selection takes place through the control inputs C1 and C2 on the circuit board. In the process, the supply voltage must always be applied together with the two control inputs.

Setting of switch S2 in position "with rectifier" = with reverse polarity protection.

The selection of the polarity of the control voltage ("+" or "-") takes place with the switch S1 on the driver board.

"+": positive control

"-": negative control (factory setting)

Caution: If the control voltage is greater than the supply voltage or the supply voltage is not applied, the operating current supply is provided through the control inputs. A corresponding load capacity must then be guaranteed.

AC-version:

In the AC version the tone selection takes place by connecting the phase "L" of the supply voltage to the control inputs C1 and C2. In the process, the supply voltage must always be applied together with the two control inputs.

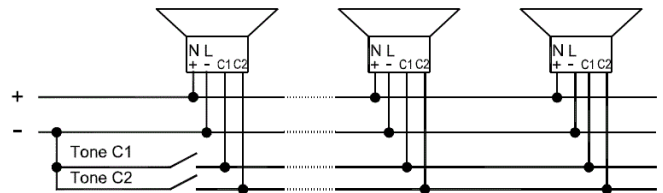
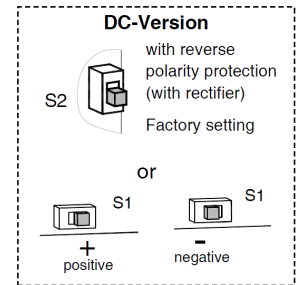
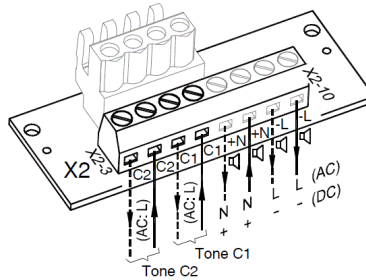

Example for DC "-" -control

Tone selection with supply through control input - for all DC versions

The sounder can be supplied with operating voltage through the control inputs C1 and C2 on the circuit board. Supply and tone selection thus take place simultaneously. The minus pole of the sounder must be connected. With connection of the positive voltage to the plus pole of the circuit board, the base tone (♯) is generated; with connection to C1 or C2 the corresponding tone is selected. With simultaneous connection of the positive voltage to C1 and C2 the tone "C1+C2" is selected. The switch S1 on the driver board must be set to "+".

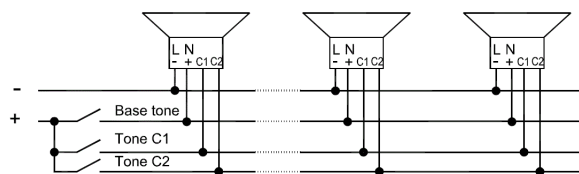
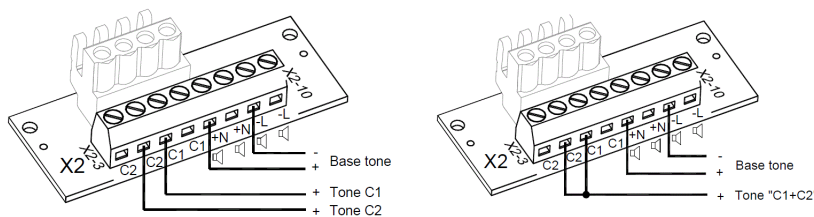

Connection example

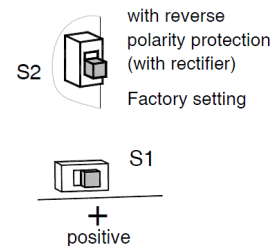

Tone selection through pole reversal - for all DC versions

If the switch S2 on the driver board is in the position "without reverse polarity protection = without rectifier", the tone "C1+C2" can be selected in addition to the base tone through pole reversal. The switch S1 must be set to "+". The control inputs C1 and C2 may not be switched on the circuit board.

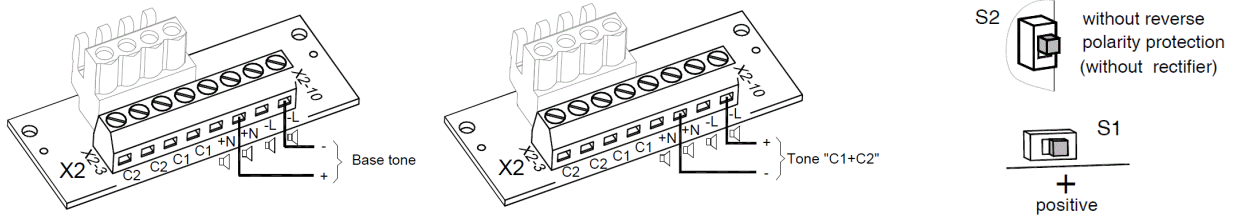

Maintenance

The device does not require any special maintenance. External cleaning should be done with a mild soap solution without the use of solvents. The device may only be operated in the undamaged state within the specified rating. Conversions, alterations, improper and inadmissible use as well as the non-observance of the notes in these operating instructions shall render the warranty null and void. Components may be replaced only by original spare parts.

jyhghgjgjug

Selection of the tones:

Selector –switch (Adjusting the base tone)							External Tone Control		
1	2	3	4	5	6	Tone # (♩)	C1 Tone No.	C2 Tone No.	C1+C2 Tone
						1		2	57
ON						2 *	128	112	57
	ON					2	26	100	93
ON	ON					2	61	131	112
		ON				9	57	11	82
ON		ON				15	131	52	112
	ON	ON				16	109	52	56
ON	ON	ON				18	111	57	68
			ON			22	16	109	68
ON			ON			23	131	52	112
	ON		ON			24	131	52	131
ON	ON		ON			25	131	52	92
		ON	ON			26	2	100	93
ON		ON	ON			27	123	52	92
	ON	ON	ON			29	35	52	61
ON	ON	ON	ON			30	27	52	77
				ON		31	131	52	57
ON				ON		33	30	52	35
	ON			ON		34	35	52	93
ON	ON			ON		35	27	52	110
		ON		ON		36	146	67	57
ON		ON		ON		43	131	52	91
	ON	ON		ON		45	2	57	93
ON	ON	ON		ON		52	15	65	82
			ON	ON		54	46	54	131
ON			ON	ON		55	131	52	128
	ON		ON	ON		56	82	35	33
ON	ON		ON	ON		59	143	59	101
		ON	ON	ON		60	131	52	125
ON		ON	ON	ON		65	131	52	93
	ON	ON	ON	ON		66	110	52	107
ON	ON	ON	ON	ON		69	131	52	110
				ON		71	131	52	93
ON				ON		77	61	52	122
	ON			ON		82	131	52	83
ON	ON			ON		83	56	2	82
		ON		ON		88	2	57	128
ON		ON		ON		90	131	52	125
	ON	ON		ON		91	30	52	110
ON	ON	ON		ON		92	33	52	57
			ON		ON	93	2	128	57
ON			ON		ON	97	2	63	93
	ON		ON		ON	100	131	52	125
ON	ON		ON		ON	101	98	102	65
		ON	ON		ON	103	131	65	147
ON		ON	ON		ON	104	103	65	101
	ON	ON	ON		ON	109	16	52	22
ON	ON	ON	ON		ON	110	131	61	91
				ON	ON	112	2	57	128
ON				ON	ON	113	52	123	104
	ON			ON	ON	115	117	116	44
ON	ON			ON	ON	116	117	93	125
		ON		ON	ON	117	93	116	125
ON		ON		ON	ON	123	27	52	77
	ON	ON		ON	ON	124	53	83	2
ON	ON	ON		ON	ON	130	2	107	67
			ON	ON	ON	131	2	112	57
ON			ON	ON	ON	135	16	56	109
	ON		ON	ON	ON	142	2	54	88
ON	ON		ON	ON	ON	143	59	93	33
		ON	ON	ON	ON	144	110	61	2
ON		ON	ON	ON	ON	146	31	67	57
	ON	ON	ON	ON	ON	148	131	52	92
ON	ON	ON	ON	ON	ON	152	110	61	13

*factory default tone setting