

4 GAS RESPONDER

CONFINED SPACE ENTRY
PORTABLE GAS DETECTOR



Quick Reference Guide

GasAlertMicro 5
from



Refer to Operating Manual for more details.
Manual provided on CD with unit at time of purchase.

Table of Contents

Getting Started	4	Clearing Gas Exposures	11
Pushbutton Operations	5	Gas Alarm Setpoints	11
Display Elements	6	Viewing the Alarm Setpoints	11
Activating the Detector	7	Stopping a Gas Alarm	12
Self-Test	7	Pump Alarm	12
Deactivating the Detector.	7	Low Battery Alarm	12
User Options Menu	7	Calibration/Setting Alarm Setpoints . . .	13
Options Menu.	7	Guidelines.	13
Backlight.	8	Calibration Procedure.	13
Confidence Beep.	8	Maintenance	16
Due-Lock	8	Replacing the Batteries.	16
Latched Alarms	8	Replacing the Sensors.	17
Passcode Protect	8	Cross Sensitivity and Contamination. . .	18
Safe Display	8	Troubleshooting	19
Fast Pump	8	Specifications	20-21
Sensor Configuration	9	Warranty	22
Sensor Enable/Disable.	9		
Span Gas Value	9		
Correction Factor	10		
Datalogger	10		
Alarms	11		
Viewing Gas Exposures.	11		

For technical support, contact:
Calibration Technologies, Inc.

920 N Trade Winds Pkwy
Columbia, MO 65201

866-394-5861

Sales@ctiengineering.com
www.ctiengineering.com

Getting Started

The 4Gas Responder is designed to warn of hazardous gas levels above user-defined alarm setpoints, typically in confined spaces.

Use the detector only as specified in this quick reference guide, otherwise the protection provided by the detector may be impaired. The detector is a personal safety device. It is your responsibility to respond properly to the alarm.

The unit is shipped with the following items:

















- Carrying case
- 4-Gas Responder portable gas detector
- Sampling wand
- 3' sampling hose
- Quick reference guide

Important

Calibration Technologies recommends to bump test the sensors before each day's use to confirm their ability to respond to gas by exposing the detector to a gas concentration that exceeds the alarm setpoints. Verify that the audible and visual alarms are activated.

Calibrate the detector on a regular schedule, depending on use and sensor exposure to poisons and contaminants. The sensors must be calibrated regularly and at least once every 6 months.

Pushbutton Operations

Pushbutton	Description
	<ul style="list-style-type: none">• To turn on detector, press .• To turn off the detector, press and hold  until the countdown is complete (from normal operation only).
	<ul style="list-style-type: none">• To increment the displayed value or scroll up, press .• To enter the user options menu, press  and  simultaneously and hold until the countdown is complete.• To clear the TWA, STEL, and MAX gas exposure readings, press  and  simultaneously and hold until the countdown is complete.• To view the date and time, alarm setpoints (TWA, STEL, low, and high) of all sensors, press .
	<ul style="list-style-type: none">• To decrement the displayed value or scroll down, press .• To initiate calibration and setting alarm setpoints, press  and  simultaneously and hold until the countdown is complete.
	<ul style="list-style-type: none">• To view the TWA, STEL, and MAX hold readings, press .• To acknowledge latched alarms, press .

Display Elements

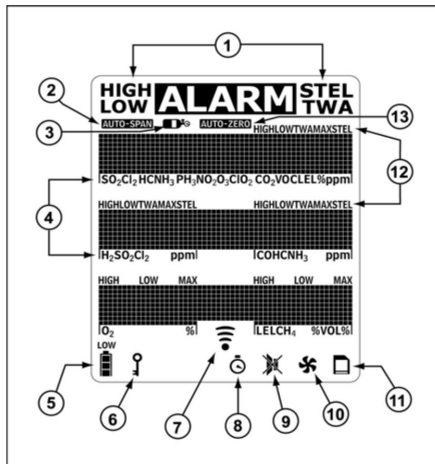

Figure 2. Screen Elements

Note

If enabled, the backlight automatically activates for 8 seconds when there is an alarm condition and whenever this is insufficient light to view the LCD. Any button reactivates the backlight in low light conditions.

Item	Description
1	Alarm condition
2	Automatically span sensor
3	Gas cylinder
4	Gas type
5	Battery life indicator
6	Passcode lock
7	Data transmission
8	Clock
9	Stealth mode
10	Pump indicator (optional)
11	MMC indicator (optional)
12	Alarm condition (low, high, TWA, STEL, or multi alarm) or view TWA, STEL and peak (MAX) gas exposures
13	Automatically zero sensor

Activating the detector

To activate the detector press .

Self-Test

Once the detector is activated, it performs self-tests on the sensors, battery, audible visual alarms and circuit integrity.

Note: During the pump test the unit will prompt you to block the inlet to the pump. Create a tight seal with your finger over the inlet until the block-inlet test is complete (approx 5 seconds).

Deactivating the detector



To deactivate the detector, press and hold  while it beeps and flashes to the corresponding countdown. At the end of the countdown the detector emits an extended beep and flash, and displays 0 before deactivating.

User Option Menu

If the detector is passcode protected, a passcode must be entered to access the user options menu. For more information, refer to Passcode Protect.

The available user options are as follows:

- 1. Exit**
- 2. Options:** backlight, confidence beep, due-lock, latch, passcode, safe, and fast pump;
- 3. Sensors:** sensor enable/disable, span gas, STEL period, TWA method, resolution, % vol CH₄, correction factor, and automatic O₂ calibration;
- 4. Logger**
- 5. Clock**
- 6. Language:** English, French, German, Spanish, and Portuguese;

To enter the user options menu, press and hold  and  simultaneously as the detector beeps and flashes to the corresponding countdown.

Options Menu

Each feature within the Options menu is enabled or disabled by pressing  to toggle the checkbox.

Backlight

The backlight (**Backlight**) option is used to enable the LCD backlight to activate automatically in low-light conditions. If disabled, the backlight is activated only when the detector is in alarm mode. The detector is shipped with the backlight option enabled.

Confidence Beep

The confidence beep (**Confibeep**) option is used to provide continuous confirmation that the detector is operating properly. When confidence beep is enabled, the audible alarm beeps once every 10 seconds. The detector is shipped with the confidence beep option disabled.

Due-Lock

If Due-lock is enabled and a sensor is overdue for calibration upon start-up, the passcode must be entered to access normal operation. If the correct passcode is not entered, the detector deactivates. The detector is shipped with the due-lock option disabled.



Latched Alarms

If enabled, the latched alarms (**Latch**) option causes the low and high gas alarms (audible, visual, and vibrator) to persist until they are acknowledged. Press  to acknowledge the alarm. The detector is shipped with the latch option disabled.

Passcode Protect

The passcode option is used to prevent unauthorized access to the user options menu, the calibration function, and to adjusting the alarm setpoints.

Note: The passcode is provided separately.

If passcode protect is enabled and the **Enter passcode: 1000** screen displays, press  or  to scroll to the correct passcode and then press  to confirm. The detector is shipped with the passcode protect option disabled.

Safe Display

When enabled, the safe option confirms that normal ambient conditions prevail and there are no gas hazards present. When all gas levels are normal or below the alarm setpoints, **Safe** displays continually on the LCD. The detector is shipped with the safe option disabled.

Fast Pump

If the sampling hose is longer than 50 ft., the **Fast pump** option must be enabled for maximum flow rate. The detector is shipped with the fast pump option disabled. If enabled, the battery life will deplete sooner.

Sensor Configuration

The **Sensor** options provide access to **additional** options and functions that are available for each sensor. Depending upon the sensor that is selected, some or all of the following options are available for configuration:

- enabling/disabling a sensor
- setting the span gas value
- adjusting the STEL period (not applicable to LEL sensor)
- resolution setting (not applicable LEL sensor)
- % vol CH4 (LEL sensor only)
- Selecting the correction factor

For all sensor options, if a value is changed but not confirmed within 5 seconds, the detector emits an audible alarm and displays the following error message. The detector retains the previous value and returns to the user options menu.

Sensor Enable/Disable

If a sensor fails, disabling the sensor deactivates the fail alarm. The sensor should be replaced and enabled as soon as possible. The detector will function normally with the remaining enabled sensors. If a sensor is enabled but it is not installed in the detector, **FAIL** displays above the gas bar of the missing sensor.

Span Gas Value

The **Span gas** option is used to increase/decrease the gas concentration level for calibration. The following span gas values are set to match the recommended calibration gas concentrations.

- O2 sensor: 18%
- LEL sensor: 2.5% Methane (50% LEL)
- CO sensor: 100 ppm
- H2S sensor: 25 ppm

Note: See page 13 for recommended calibration gas.

STEL Period

The detector is shipped with the STEL calculation period set to 15 minutes.

TWA Method

The **TWA** method is used to select either the OSHA or ACGIH calculating method.

OSHA Method: 8 hour moving average.

Resolution

This option is used to display the gas measurement using **Regular** or **Extra** resolution.

Note: The LEL sensor does not have resolution settings.

% Vol CH4 (LEL Sensor Only)

If the %vol is enabled, any currently enabled correction factor is ignored and the detector operates assuming a methane (CH₄) calibration. The detector is shipped with %vol disabled.

Correction Factor (CF)

LEL Sensor

This option is used to enter compensation factors for hydrocarbons other than methane. The factor can only be applied if the LEL sensor has been calibrated with methane.

Datalogger

The Logger option is used to define how often the detector records a datalog sample (once every 1 to 127 seconds). The datalogger records information that can be compiled to create a report.

The MMC/SD card (located underneath the battery pack) is automatically formatted during the startup self-test and becomes active.

The datalog files can be downloaded from the MMC/SD card into most spreadsheet applications using a card reader.

To view a datalog file, deactivate the 4GAS Responder and remove the SD card. Insert the card into a card reader and open the LOGFILE0.csv file.

Storage: 500,000 lines of data available; 4.4 months at 5 second intervals (based on a normal work week).

Memory type: Wrap-around memory ensures most recent data is always saved.

Approved MMC and SD cards: 128 MB Delkin SD card and 64 MB Unigen SD card.

Alarms

If more than one type or level of alarm exists simultaneously, a multi-gas alarm will result. To change the factory-set alarm setpoints, refer to Calibration and Alarm Setpoints on pages 13 and 14. During an alarm condition, the detector activates the backlight and displays the current ambient gas reading.



Viewing Gas Exposures



Press and hold  until the MAX gas exposures screen displays.

The TWA gas exposures display next.

Lastly, the STEL gas exposures display.

Clearing Gas Exposures

The exposures automatically clear after 5 minutes of the detector being deactivated. To clear the MAX, TWA, and STEL exposure readings immediately, press and hold  and  simultaneously. The detector displays the following screen during the countdown.

Note: Hold  and  for the entire countdown, otherwise the MAX, TWA, and STEL exposure readings will not clear.

Gas Alarm Setpoints

The gas alarm setpoints trigger the gas alarms and are described in the list below.

Low alarm (Toxics and combustibles): Ambient gas level above low alarm setpoint.

High alarm (Toxics and combustibles): Ambient gas level above high alarm setpoint.

TWA alarm (Toxic only): Accumulated value above the TWA alarm setpoint.

STEL alarm (Toxic only): Accumulated value above the STEL alarm setpoint.

Downscale alarm (Toxic): If sensor reading is negative (half of the TWA setpoint). (LEL): If sensor reading is negative (half of the low alarm setpoint).

Multi-gas alarm: Two or more gas alarm conditions.

Viewing the Alarm Setpoints

To view the current alarm setpoints for all of the sensors, press  during normal operation.

The alarm setpoint screens are displayed in the following order: TWA, STEL, low alarm, and high alarm.

If a correction factor has been applied to a sensor, one of the following screens display indicating the sensor and gas type.



Stopping a Gas Alarm

The low and high alarms stop when the ambient gas level returns to below the low alarm setpoint.

Note: If alarms are set to latch, press  to reset the alarms.

The TWA and STEL alarms can be stopped either by clearing the MAX, TWA, and STEL peak exposures (refer to Clearing Gas Exposures on page 11), or deactivating the detector for 5 minutes (minimum) and then reactivating it again.

Pump Alarm

If the pump stops operating or becomes blocked, the detector activates the pump alarm. The pump alarm continues until the blockage is cleared or it is acknowledged by pressing . If  is pressed, the detector automatically launches a pump test to reset the pump module. Follow the instructions on the display when prompted to complete the pump test. If the pump test is successful, the detector returns to normal operation, otherwise the pump alarm continues.

Low Battery Alarm

Replace batteries immediately.

Note: Typically, the low battery alarm allows for 5 minutes of runtime before the detector automatically shuts off.

Calibration and Alarm Setpoints

Calibration Technologies provides rapid turnaround calibration service, which includes a certificate of calibration that satisfies OSHA PSM documentation requirements for the detector. At minimum, six month intervals are recommended.

Call 866-394-5861 to arrange shipment. Use address on page 3 for shipping.

Guidelines



When calibrating the detector, adhere to the following guidelines:

- The detector is shipped with a factory calibration. Calibrate the detector on a regular schedule, depending on use and sensor exposure to poisons and contaminants. CTI recommends bump testing the detector before each use, and calibrate once every 180 days (6 months) under normal use.
- Required gas cal gas:
- Order #: **RB34L-4gas-B** (100 ppm CO, 25 ppm H₂S, 50% LEL CH₄, 18% O₂)
- Special calibration gas mixes and kits are available from Calibration Technologies.
- If a certified calibration is required, contact Calibration Technologies.

Calibration Procedure (AutoCal)

Verify that the calibration gas being used matches the span concentration values that are set for the detector. Refer to Span Gas Value section on page 9.

Start Calibration

1. To enter calibration, press and hold  and  simultaneously as the detector beeps, flashes, and vibrates to the corresponding countdown. The detector then reads Starting calibration.

Auto Zero

2. **Auto Zero** flashes while the detector automatically zeroes the sensors. Do not apply calibration gas during this process, otherwise the auto zero step will fail.

Auto Span

3. Next, three screens are displayed:

- Apply span gas now to calibrate (recommended) (skip to step #4)

- or press  to select sensor(s)

- or press  to skip calibration (skip to step #5)

Apply Span Gas Now

4. *Note: turn on gas flow prior to connecting to the portable to prevent a pump failure alarm.* Attach the calibration hose to the regulator outlet and apply gas to the unit at a flow rate of 0.5 to 0.8 l/min. The cal gas cylinder icon flashes as the detector initially detects the calibration gas. After 30 seconds the detector beeps and the cal gas cylinder stops flashing. **Auto Span** flashes while spanning the respective sensor until the detector has attained a sufficient level of the expected gas. Wait until the spanning countdown is complete.

5. When the span is complete, the following screens are displayed:

- Calibration successful

- Press **▲** to apply new cal gas (repeat step #4)

- Press **▼** to end span

Remove hose and turn off cal gas. The display then advises to press **○** to set or **Ⓟ** to bypass the calibration due dates.

Calibration Due Dates

Press **▼** or **▲** to change the calibration due date.

Press **○** to accept this value and proceed to the next due date. If a sensor failed or did not span, you cannot change the calibration due date for that sensor. Unless a new due date value is entered, the detector automatically resets to the previously entered number of days (e.g. 180). The display then advises to press **○** to set or **Ⓟ** to bypass the alarm setpoints.

Alarm Setpoints

Press **▼** or **▲** to change the alarm setpoint. Press **○** to save the displayed value and proceed to the next setpoint. Set the remaining setpoints. The detector beeps twice at the end of the alarm setpoint stage.

Finish Calibration

The detector then saves the calibration data, and returns to normal operation.

Maintenance

Replacing the Batteries

1. Open the latch on the bottom of the detector.
2. Remove the battery pack by lifting the bottom of the pack away from the detector.
3. Unscrew the two captive screws on the battery pack and open the pack.
4. Replace the three AA batteries and screw the battery pack back together.
5. Reinsert the battery pack and secure the latch.

Note: The 4Gas Responder can operate on alkaline or lithium cells.

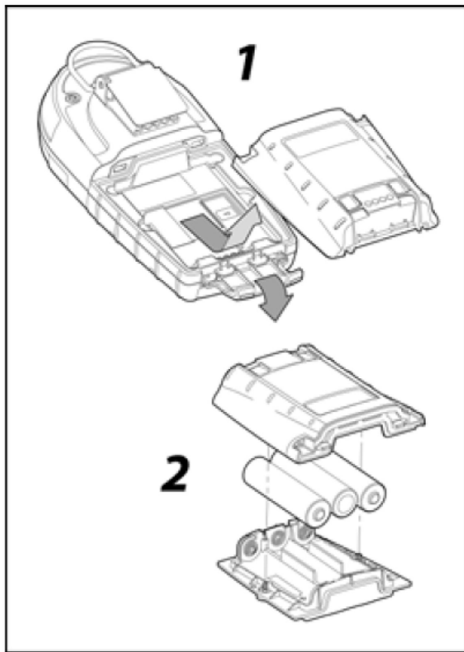

Replacing the Sensors

1. Deactivate the detector.
2. Remove the two machine screws on the rear shell and then remove the sensor cover or pump module.
3. Remove the sensor filter and/or sensor(s).
4. Insert the new filter and/or sensor(s). Ensure the sensor posts are aligned correctly.
5. Re-assemble the detector.
6. Calibrate unit

Note: If a replacement sensor is needed, call for replacement sensor and calibration gas, or return detector to Calibration Technologies for service. 866-394-5861.

Item	Description
1	Sensor cover
2	Sensor filter
3	Sensors
4	Detector
5	Machine screws (2)

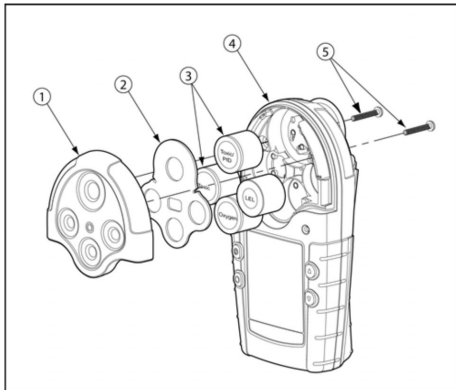

Cross Sensitivity and Contamination

The LEL sensor will respond to most combustible gases. Interference gases are not likely to be 1% LEL in most facilities so readings from cross sensitivity are uncommon.

- It is recommended that the combustible sensor be checked with a known concentration of calibration gas after any known exposure to contaminants/poisons (sulfur compounds, silicon vapors, halogenated compounds, etc.).
- Protect the combustible sensor from exposure to lead compounds, silicones, and chlorinated hydrocarbons. Although certain organic vapors (such as leaded gasoline and halogenated hydrocarbons) may temporarily inhibit sensor performance, in most cases, the sensor will recover after calibration.
- Any rapid up-scaling reading followed by a declining or erratic reading may indicate a gas concentration beyond upper scale limit, which may be hazardous.
- Extended exposure to certain concentrations of combustible gases may stress a sensor element and can seriously affect its performance. If an alarm occurs due to high concentration of combustible gases, recalibrate the sensor, or if required, replace the sensor.

Troubleshooting

If a problem occurs, refer to the problem / possible solutions list below. If the problem persists or the problem that your detector is experiencing is not listed, contact Calibration Technologies.

The detector does not activate or automatically deactivates:

Possible cause:

- Depleted batteries.

Solution:

- Replace batteries.

Pump trouble or failure:

Possible cause:

- Flow change detected.

Solution:

- Make sure inlet is not blocked.
- Check filter and replace if dirty.

For technical support, contact:
Calibration Technologies, Inc.

920 N Trade Winds Pkwy
Columbia, MO 65201

866-394-5861

Sales@ctiengineering.com
www.ctiengineering.com

Specifications

Instrument dimensions: 5.7" x 2.9" x 1.5"

Weight: 13.1 oz.

Humidity: 5 - 95% relative humidity (non-condensing)

Operating temperature: 0°F - +120°F

Alarm setpoints: May vary by region and are user-settable.

Detection range:

O₂ sensor: 0 - 30% vol (0.1% increments)

CO sensor: 0 - 500 ppm (1 ppm increments)

H₂S sensor: 0 - 100 ppm (1 ppm increments)

Combustible (LEL): 0-100% LEL (1% increments) or 0-5.0% v/v methane (0.1% increments)

Sensor type:

H₂S/CO sensor: Twin plug-in electrochemical cell

LEL sensor: Plug-in catalytic bead

O₂ sensor: Single plug-in electrochemical cell

Alarm conditions: TWA alarm, STEL alarm, low alarm, high alarm, multi-gas alarm, over range alarm, sensor alarm, pump alarm, low battery alarm, confidence beep, automatic shutdown alarm

Audible alarm: 95 dB at 1 ft. variable pulsed dual beepers

Visual alarm: Dual red light-emitting diodes (LED)

Display: Alphanumeric liquid crystal display (LCD)

Backlight: Automatically activates whenever there is insufficient light to view the LCD (if enabled) and during alarm conditions.

Self-test: Initiated upon activation

Calibration: Every 6 months, minimum

User field options: Confidence beep, latching low and high alarms, pass code protection, enable/disable safe display mode, enable/disable fast pump, combustible sensor measurement, sensor disable, TWA and STEL, language selection, set span concentration values, set STEL calculation period, set TWA method, gas measurement resolution, enable/disable automatic backlight, adjust clock calendar, and set logging rate (datalogger models only).

Battery operating time: 18-20 hours typical. Runtime decreases depending on backlight activation.

Warranty: 1 year including sensors

Approvals: Approved by CSA to both U.S. and Canadian Standards

Approved: Class I, Division 1, Group A, B, C, and D; Class I, Zone 0, Group IIC

Standards: CAN/CSA C22.2 No. 157 and C22.2 152
ANSI/UL – 913 and ANSI/ISA – S12.13 Part 1

Limited Warranty & Limitation of Liability

Calibration Technologies, Inc. (CTI) warrants this product to be free from defects in material and workmanship under normal use and service for a period of one year, beginning on the date of shipment to the buyer. This warranty extends only to the sale of new and unused products to the original buyer. CTI's warranty obligation is limited, at CTI's option, to refund of the purchase price, repair, or replacement of a defective product that is returned to a CTI authorized service center within the warranty period. In no event shall CTI's liability hereunder exceed the purchase price actually paid by the buyer for the Product.

This warranty does not include:

- a) replacement sensor elements, disposable batteries or the routine replacement of parts due to the normal wear and tear of the product arising from use;
- b) any product which in CTI's opinion, has been misused, altered, neglected or damaged by accident or abnormal conditions of operation, handling or use;
- c) any damage or defects attributable to repair of the product by any person other than an authorized dealer, or the installation of unapproved parts on the product; or

The obligations set forth in this warranty are conditional on:

- a) proper storage, installation, calibration, use, maintenance and compliance with the product manual instructions and any other applicable recommendations of CTI;
- b) the buyer promptly notifying CTI of any defect and, if required, promptly making the product available for correction. No goods shall be returned to CTI until receipt by the buyer of shipping instructions from CTI; and
- c) the right of CTI to require that the buyer provide proof of purchase such as the original invoice, bill of sale or packing slip to establish that the product is within the warranty period.

THE BUYER AGREES THAT THIS WARRANTY IS THE BUYER'S SOLE AND EXCLUSIVE REMEDY AND IS IN LIEU OF ALL OTHER WARRANTIES, EXPRESS OR IMPLIED, INCLUDING BUT NOT LIMITED TO ANY IMPLIED WARRANTY OF MERCHANTABILITY OR FITNESS FOR A PARTICULAR PURPOSE. CTI SHALL NOT BE LIABLE FOR ANY SPECIAL, INDIRECT, INCIDENTAL OR CONSEQUENTIAL DAMAGES OR LOSSES, INCLUDING LOSS OF DATA, WHETHER ARISING FROM BREACH OF WARRANTY OR BASED ON CONTRACT, TORT OR RELIANCE OR ANY OTHER THEORY.



4-GAS-RESP-DOC1-0
20171227

ctiengineering.com | 866-394-5861